

MAS-403 BT, CON CUERPO EQUILIBRADO, PARA FRESAS (WELDON)
SEGÚN DIN 1835 B Y DIN 6535 HB. SE SUMINISTRA CON TORNILLO
DE...

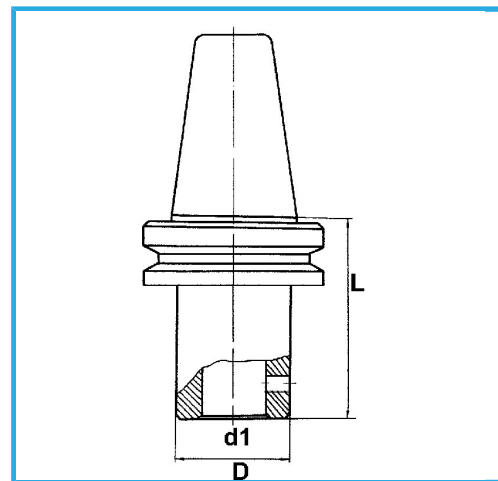

€138,00



Buril	50
d1 - h6	8 mm
D	28 mm
L	65 mm
Peso bruto	3,69 kg
Codigo de barras	8012667193089



Caja



Rectificado

18Ni
CrMo5