

MAS-403 BT, AUSGEWUCHTETES SPANNFUTTERGEHÄUSE, FÜR FRÄSER (WELDON) NACH DIN 1835 B UND DIN 6535 HB. LIEFERUNG MIT..

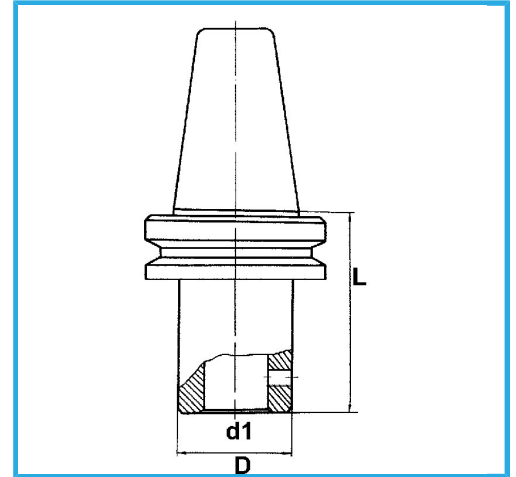

BT	40
d1 - h6	10 mm
D	35 mm
L	60 mm
Bruttogewicht	1,12 kg
EAN-Code	8012667195908



Box



Korrigiert



18Ni
CrMo5

-