

MAS-403 BT, CORPO MANDRINO BILANCIATO, PER FRESE (WELDON)
SECONDO NORMA DIN 1835 B E DIN 6535 HB. FORNITO CON VITE DI
SERRAGGIO...

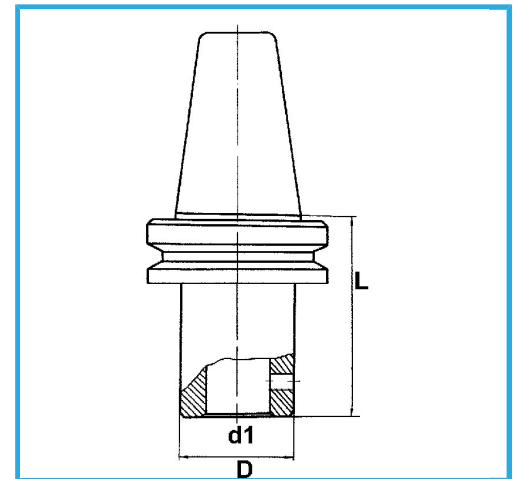

€105,00



BT	40
d1 - h6	10 mm
D	35 mm
L	60 mm
Peso lordo	1,12 kg
Codice EAN	8012667195908



Scatola



Rettificato

18Ni
CrMo5