

MAS-403 BT, AUSGEWUCHTETES SPANNFUTTERGEHÄUSE, FÜR
FRÄSER (WELDON) NACH DIN 1835 B UND DIN 6535 HB. LIEFERUNG
MIT..

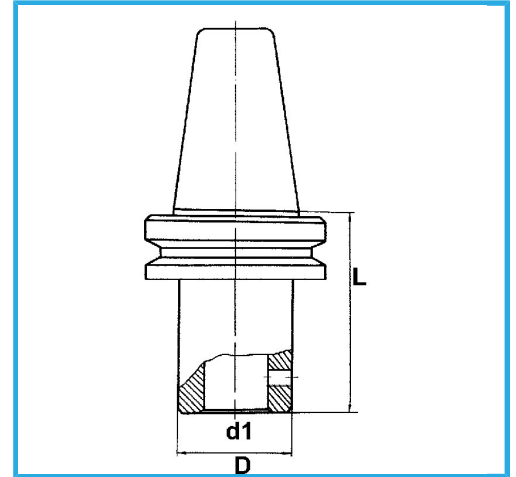

BT	40
d1 - h6	14 mm
D	42 mm
L	70 mm
Bruttogewicht	1,35 kg
EAN-Code	8012667195946



Box



Korrigiert



18Ni
CrMo5

-