

MAS-403 BT, AUSGEWUCHTETES SPANNFUTTERGEHÄUSE, FÜR  
FRÄSER (WELDON) NACH DIN 1835 B UND DIN 6535 HB. LIEFERUNG  
MIT..

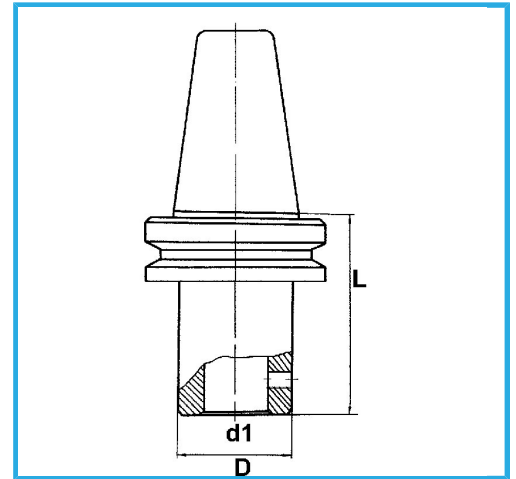

BT	50
d1 - h6	16 mm
D	48 mm
L	80 mm
Bruttogewicht	4,06 kg
EAN-Code	8012667193195



Box



Korrigiert



18Ni  
CrMo5

-