

MAS-403 BT, CON CUERPO EQUILIBRADO, PARA FRESAS (WELDON)
SEGÚN DIN 1835 B Y DIN 6535 HB. SE SUMINISTRA CON TORNILLO
DE...

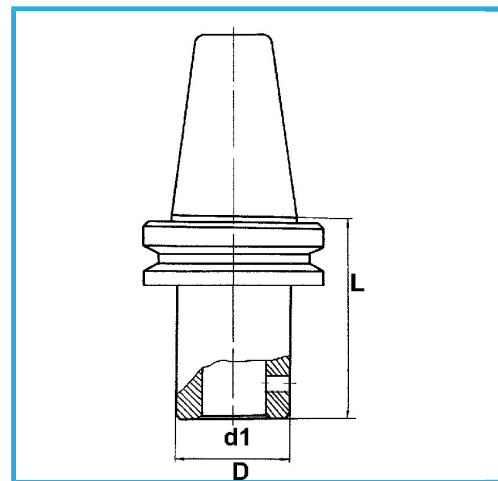

€138,00



Buril	50
d1 - h6	16 mm
D	48 mm
L	80 mm
Peso bruto	4,06 kg
Codigo de barras	8012667193195



Caja



Rectificado

18Ni
CrMo5