

MAS-403 BT, CORPO MANDRINO BILANCIATO, PER FRESE (WELDON)
SECONDO NORMA DIN 1835 B E DIN 6535 HB. FORNITO CON VITE DI
SERRAGGIO...

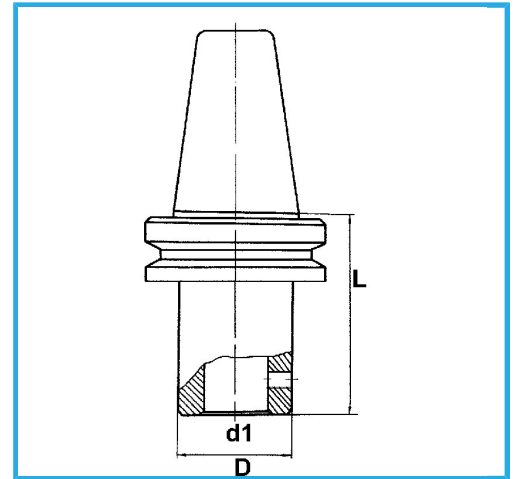

€138,00



| | |
|------------|---------------|
| BT | 50 |
| d1 - h6 | 16 mm |
| D | 48 mm |
| L | 80 mm |
| Peso lordo | 4,06 kg |
| Codice EAN | 8012667193195 |



Scatola



Rettificato

18Ni
CrMo5