

MAS-403 BT, CORPO MANDRINO BILANCIATO, PER FRESE (WELDON)  
SECONDO NORMA DIN 1835 B E DIN 6535 HB. FORNITO CON VITE DI  
SERRAGGIO...

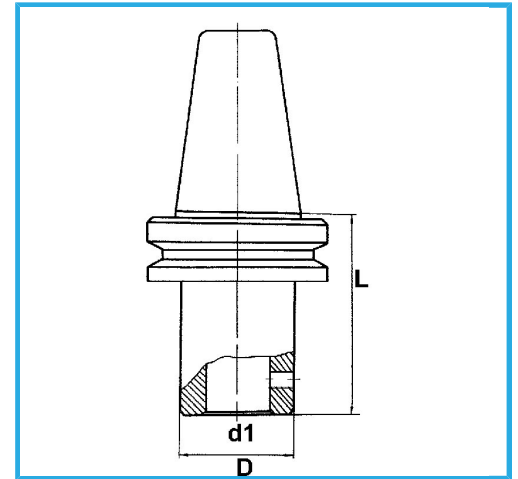

€105,00



BT	40
d1 - h6	18 mm
D	48 mm
L	70 mm
Peso lordo	1,49 kg
Codice EAN	8012667195984



Scatola



Rettificato

18Ni  
CrMo5