

MAS-403 BT, BALANCED CHUCK BODY, FOR MILLING CUTTERS  
(WELDON) ACCORDING TO DIN 1835 B AND DIN 6535 HB. SUPPLIED  
WITH TIGHTENING...

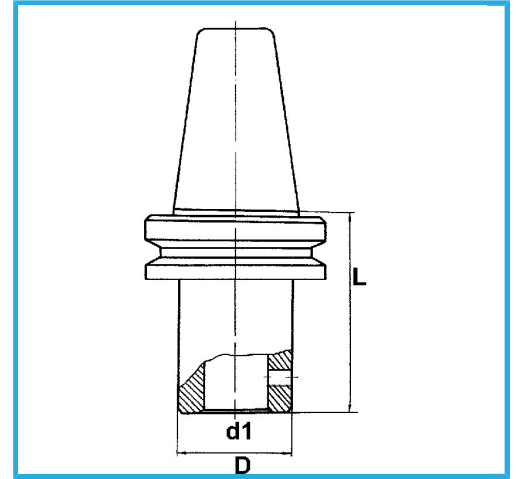

BT	50
d1 - h6	18 mm
D	48 mm
L	80 mm
Gross weight	4,10 kg
EAN Code	8012667195410



Box



Grounded



18Ni  
CrMo5

-