

MAS-403 BT, CORPO MANDRINO BILANCIATO, PER FRESE (WELDON)
SECONDO NORMA DIN 1835 B E DIN 6535 HB. FORNITO CON VITE DI
SERRAGGIO...

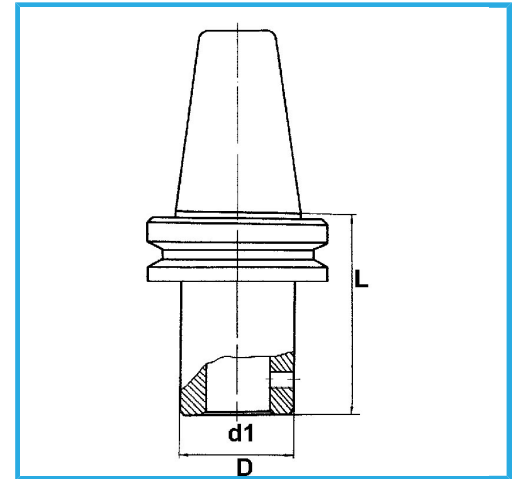

€138,00



BT	50
d1 - h6	18 mm
D	48 mm
L	80 mm
Peso lordo	4,10 kg
Codice EAN	8012667195410



Scatola



Rettificato

18Ni
CrMo5