

MAS-403 BT, CORPO MANDRINO BILANCIATO, PER FRESE (WELDON)
SECONDO NORMA DIN 1835 B E DIN 6535 HB. FORNITO CON VITE DI
SERRAGGIO...

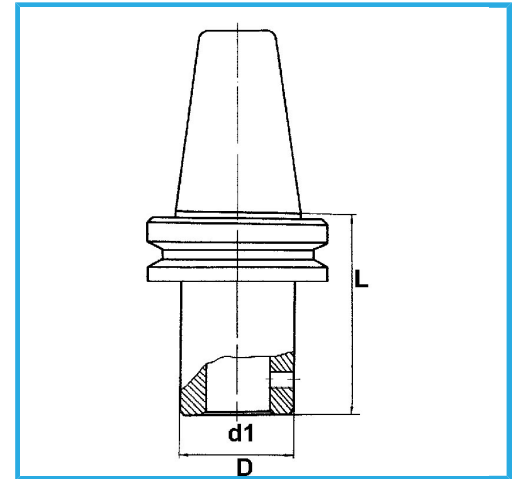

€105,00



BT	40
d1 - h6	20 mm
D	52 mm
L	75 mm
Peso lordo	1,61 kg
Codice EAN	8012667196004



Scatola



Rettificato

18Ni
CrMo5