

MAS-403 BT, CON CUERPO EQUILIBRADO, PARA FRESAS (WELDON)
SEGÚN DIN 1835 B Y DIN 6535 HB. SE SUMINISTRA CON TORNILLO
DE...

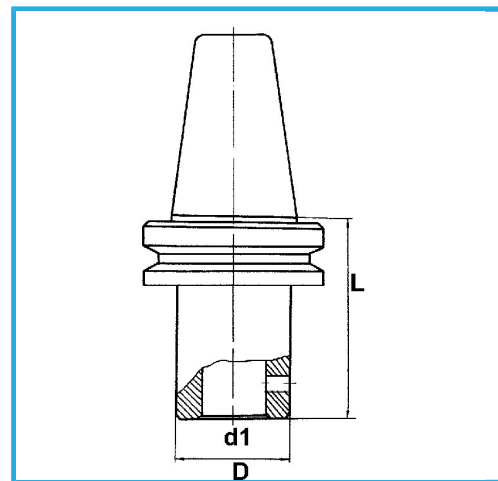

€138,00



| | |
|------------------|---------------|
| Buril | 50 |
| d1 - h6 | 20 mm |
| D | 52 mm |
| L | 80 mm |
| Peso bruto | 4,13 kg |
| Codigo de barras | 8012667195427 |



Caja



Rectificado



18Ni
CrMo5