

MAS-403 BT, CORPO MANDRINO BILANCIATO, PER FRESE (WELDON)
SECONDO NORMA DIN 1835 B E DIN 6535 HB. FORNITO CON VITE DI
SERRAGGIO...

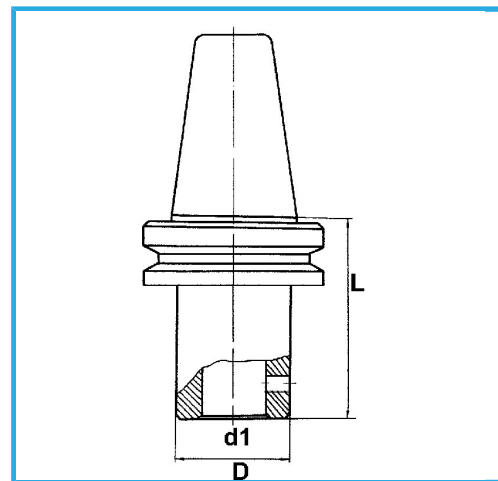

€105,00



BT	40
d1 - h6	25 mm
D	63 mm
L	100 mm
Peso lordo	2,50 kg
Codice EAN	8012667196035



Scatola



Rettificato



18Ni
CrMo5