

MAS-403 BT, AUSGEWUCHTETES SPANNFUTTERGEHÄUSE, FÜR
FRÄSER (WELDON) NACH DIN 1835 B UND DIN 6535 HB. LIEFERUNG
MIT..

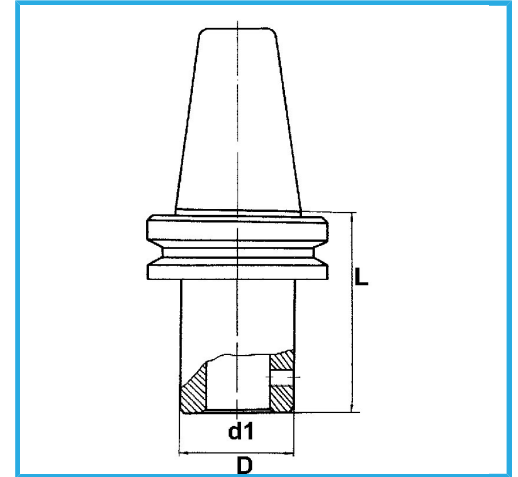

BT	40
d1 - h6	32 mm
D	72 mm
L	100 mm
Bruttogewicht	2,00 kg
EAN-Code	8012667196059



Box



Korrigiert



18Ni
CrMo5

-