

MAS-403 BT, CORPO MANDRINO BILANCIATO, PER FRESE (WELDON)  
SECONDO NORMA DIN 1835 B E DIN 6535 HB. FORNITO CON VITE DI  
SERRAGGIO...

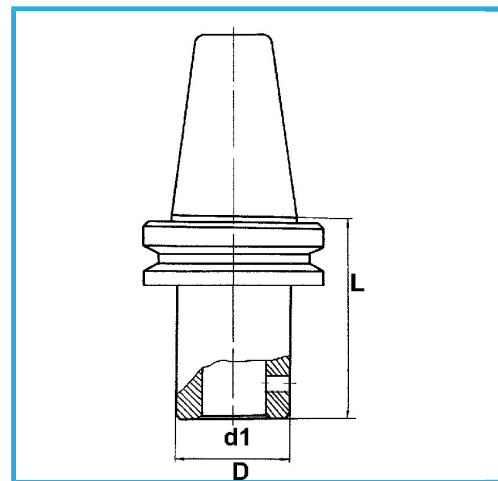

€105,00



BT	40
d1 - h6	32 mm
D	72 mm
L	100 mm
Peso lordo	2,00 kg
Codice EAN	8012667196059



Scatola



Rettificato



18Ni  
CrMo5