

MAS-403 BT, AUSGEWUCHTETES SPANNFUTTERGEHÄUSE, FÜR FRÄSER (WELDON) NACH DIN 1835 B UND DIN 6535 HB. LIEFERUNG MIT..

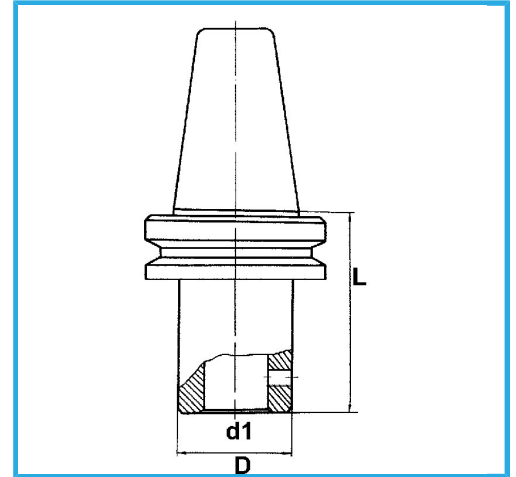

BT	50
d1 - h6	32 mm
D	72 mm
L	105 mm
Bruttogewicht	5,19 kg
EAN-Code	8012667195441



Box



Korrigiert



18Ni
CrMo5

-