

MAS-403 BT, CORPO MANDRINO BILANCIATO, PER FRESE (WELDON)
SECONDO NORMA DIN 1835 B E DIN 6535 HB. FORNITO CON VITE DI
SERRAGGIO...

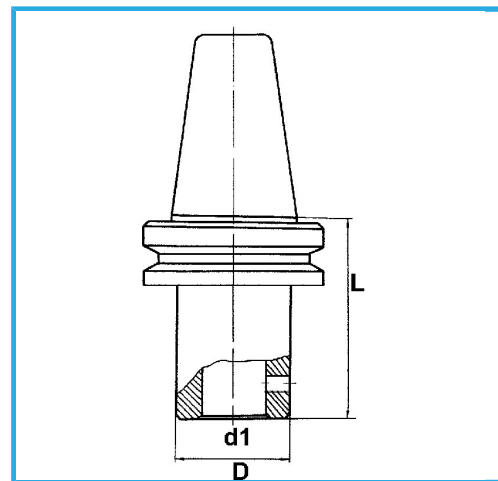

€154,00



BT	50
d1 - h6	32 mm
D	72 mm
L	105 mm
Peso lordo	5,19 kg
Codice EAN	8012667195441



Scatola



Rettificato



18Ni
CrMo5