

MAS-403 BT, AUSGEWUCHTETES SPANNFUTTERGEHÄUSE, FÜR
FRÄSER (WELDON) NACH DIN 1835 B UND DIN 6535 HB. LIEFERUNG
MIT..

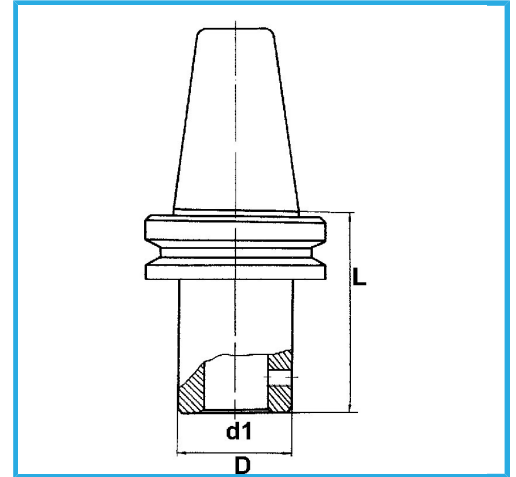

BT	50
d1 - h6	40 mm
D	80 mm
L	120 mm
Bruttogewicht	6,66 kg
EAN-Code	8012667195458



Box



Korrigiert



18Ni
CrMo5

-