

DIN 2080, AUSGEWUCHTETES SPANNFUTTERGEHÄUSE.
AUSWUCHTDREHZAHN 2.000 RPM.

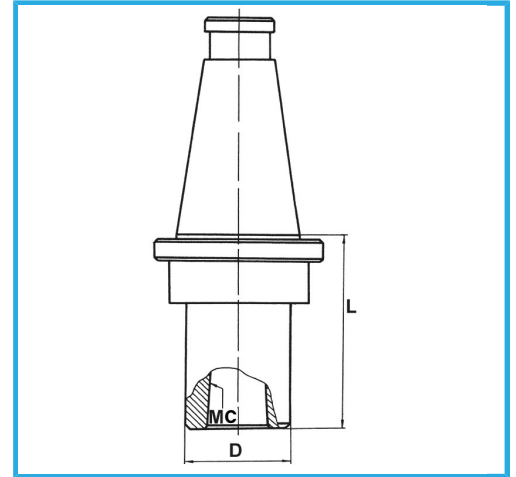

ISO	40
CM	1
D	25 mm
L	15 mm
Bruttogewicht	0,92 kg
EAN-Code	8012667008208



Box



Korrigiert

18Ni
CrMo5

-