

DIN 2080, CORPO MANDRINO BILANCIATO. EQUILIBRATURA 2.000 RPM.

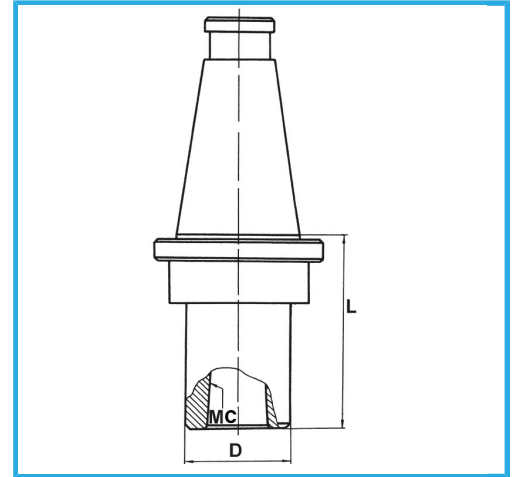

€127,00



ISO	40
CM	2
D	32 mm
L	30 mm
Peso lordo	0,85 kg
Codice EAN	8012667008215



Scatola



Rettificato

18Ni
CrMo5