

DIN 2080, AUSGEWUCHTETES SPANNFUTTERGEHÄUSE.  
AUSWUCHTDREHZAHN 2.000 RPM.

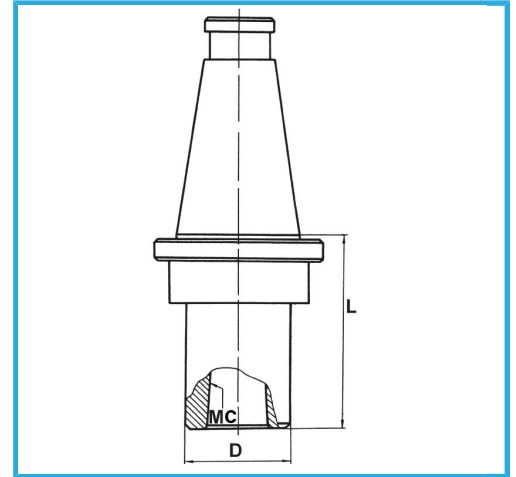

ISO	50
CM	2
D	32 mm
L	20 mm
Bruttogewicht	2,77 kg
EAN-Code	8012667008246



Box



Korrigiert



18Ni  
CrMo5

-