

DIN 2080, CORPO MANDRINO BILANCIATO. EQUILIBRATURA 2.000 RPM.

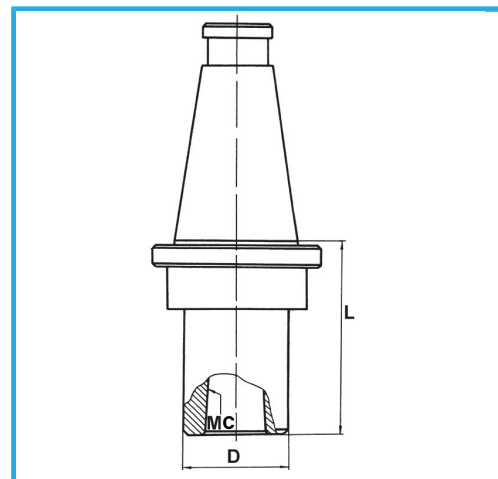

€171,00



ISO	50
CM	2
D	32 mm
L	20 mm
Peso lordo	2,77 kg
Codice EAN	8012667008246



Scatola



Rettificato

18Ni
CrMo5