

DIN 2080, AUSGEWUCHTETES SPANNFUTTERGEHÄUSE.
AUSWUCHTDREHZAHL 2.000 RPM.

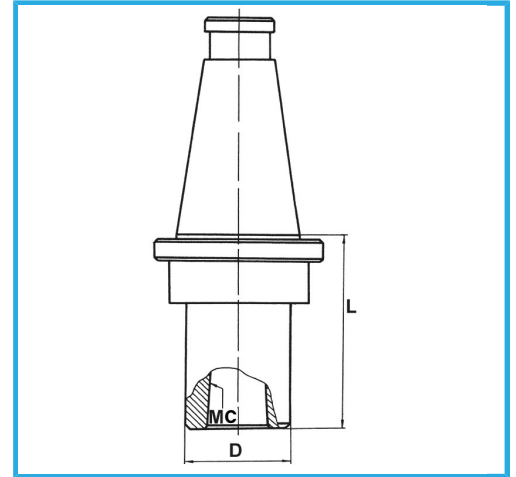

ISO	40
CM	3
D	40 mm
L	64 mm
Bruttogewicht	1,12 kg
EAN-Code	8012667008222



Box



Korrigiert

18Ni
CrMo5

-