

DIN 2080, BALANCED CHUCK BODY. BALANCING 2.000 RPM.

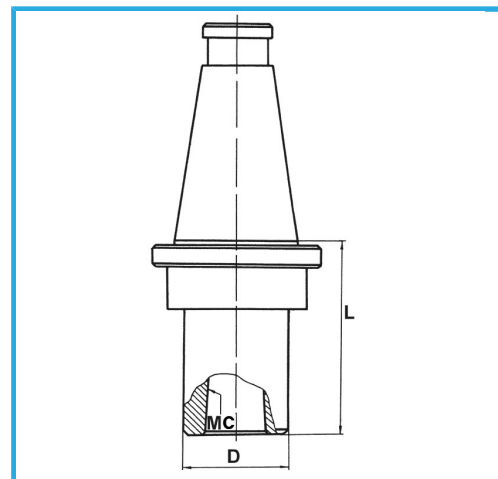

ISO	50
MT	3
D	40 mm
L	30 mm
Gross weight	3,12 kg
EAN Code	8012667008253



Box



Grounded



18Ni
CrMo5

-