

DIN 2080, AUSGEWUCHTETES SPANNFUTTERGEHÄUSE.
AUSWUCHTDREHZAHN 2.000 RPM.

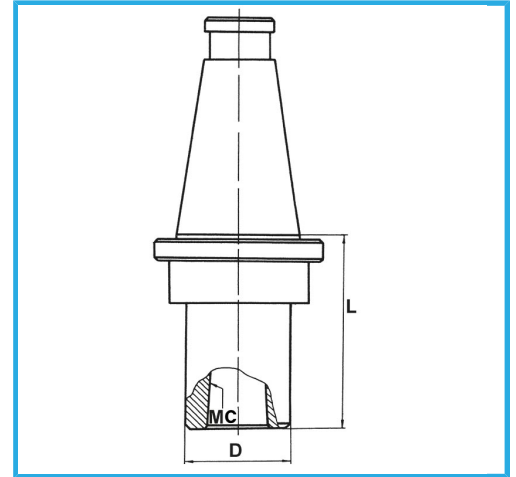

ISO	40
CM	4
D	50 mm
L	94 mm
Bruttogewicht	1,49 kg
EAN-Code	8012667008239



Box



Korrigiert

18Ni
CrMo5

-