

DIN 2080, AUSGEWUCHTETES SPANNFUTTERGEHÄUSE.
AUSWUCHTDREHZAHN 2.000 RPM.

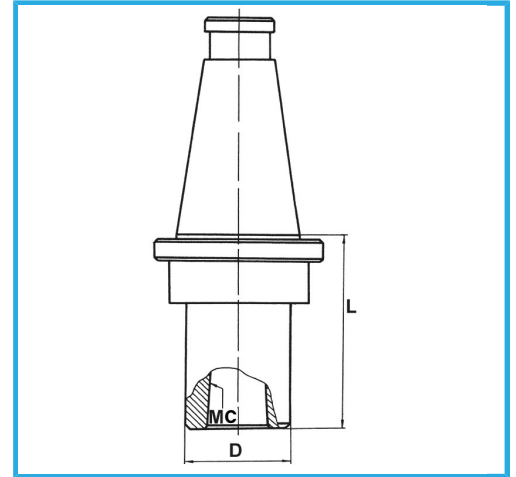

ISO	50
CM	4
D	50 mm
L	65 mm
Bruttogewicht	3,14 kg
EAN-Code	8012667008260



Box



Korrigiert



18Ni
CrMo5

-