

DIN 2080, BALANCED CHUCK BODY. BALANCING 2.000 RPM.

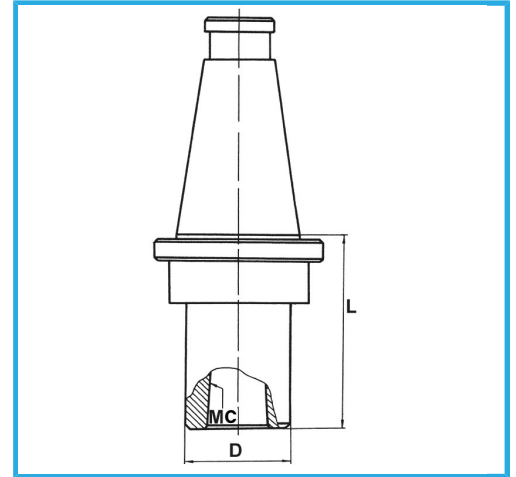

ISO	50
MT	4
D	50 mm
L	65 mm
Gross weight	3,14 kg
EAN Code	8012667008260



Box



Grounded



18Ni
CrMo5

-