

MAS-403 BT, BALANCED CHUCK BODY, FOR CYLINDRICAL END MILLS
ACCORDING TO DIN 481, FOR MILLING CUTTERS WITH LONGITUDINAL
GROOVE...

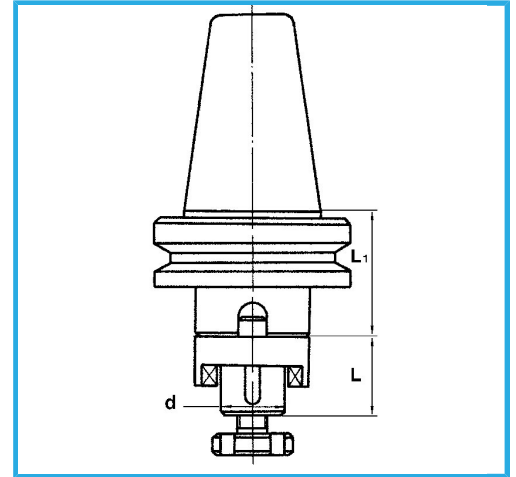

BT	40
d - h6	22 mm
L	31 mm
L1	35 mm
Gross weight	2,00 kg
EAN Code	8012667008543



Box



Tempered



Grounded



18Ni
CrMo5