

MAS-403 BT, CON CUERPO EQUILIBRADO, PARA FRESAS CILÍNDRICAS SEGÚN DIN 481, PARA FRESAS CON RANURA LONGITUDINAL DIN...

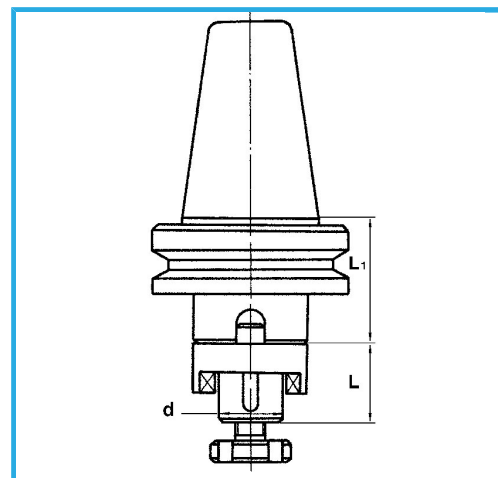

€119,00



| | |
|------------------|---------------|
| Buril | 40 |
| d - h6 | 22 mm |
| L | 31 mm |
| L1 | 35 mm |
| Peso bruto | 2,00 kg |
| Codigo de barras | 8012667008543 |



Caja



Templado



Rectificado



18Ni
CrMo5