

MAS-403 BT, AUSGEWUCHTETES SPANNFUTTERGEHÄUSE, FÜR
ZYLINDRISCHE SCHAFTFRÄSER NACH DIN 481, FÜR FRÄSER...

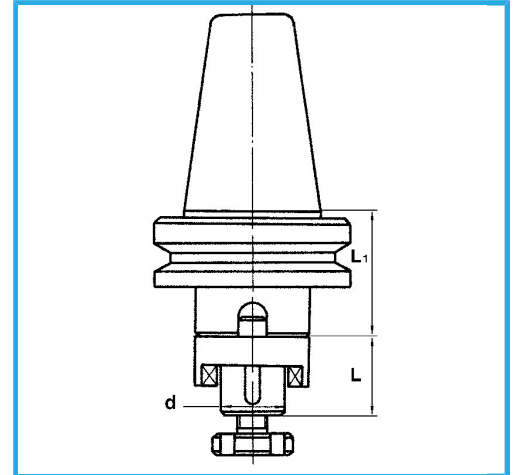

BT	50
d - h6	22 mm
L	31 mm
L1	35 mm
Bruttogewicht	4,31 kg
EAN-Code	8012667008581



Box



Gehärteter



Korrigiert



18Ni
CrMo5