

MAS-403 BT, CON CUERPO EQUILIBRADO, PARA FRESAS CILÍNDRICAS SEGÚN DIN 481, PARA FRESAS CON RANURA LONGITUDINAL DIN...

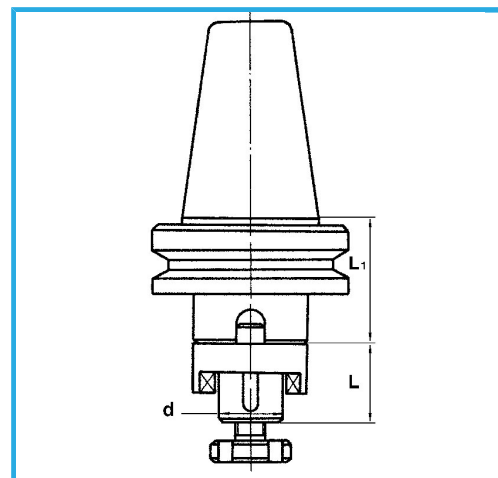

€166,00



Buril	50
d - h6	22 mm
L	31 mm
L1	35 mm
Peso bruto	4,31 kg
Codigo de barras	8012667008581



Caja



Templado



Rectificado



18Ni
CrMo5