

MAS-403 BT, CORPO MANDRINO BILANCIATO, PER FRESE
CILINDRICHE FRONTALI SECONDO NORMA DIN 481, PER FRESE CON
SCANALATURA...

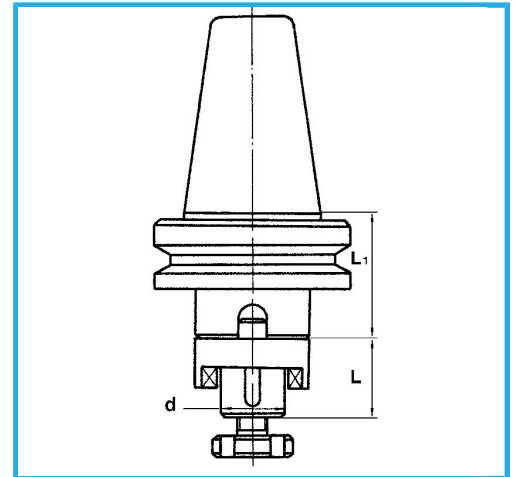

€166,00



BT	50
d - h6	22 mm
L	31 mm
L1	35 mm
Peso lordo	4,31 kg
Codice EAN	8012667008581



Scatola



Temprato



Rettificato



18Ni
CrMo5