

MAS-403 BT, AUSGEWUCHTETES SPANNFUTTERGEHÄUSE, FÜR
ZYLINDRISCHE SCHAFTFRÄSER NACH DIN 481, FÜR FRÄSER...

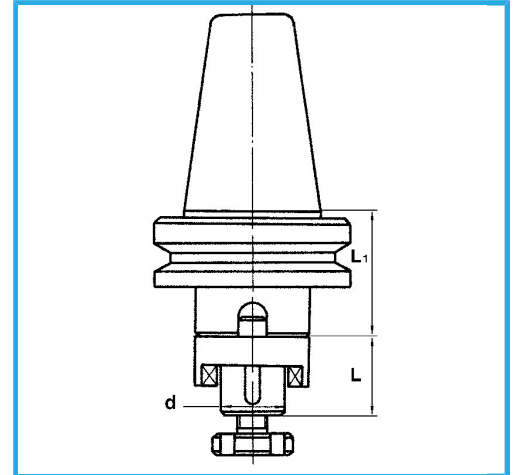

BT	40
d - h6	27 mm
L	33 mm
L1	35 mm
Bruttogewicht	2,00 kg
EAN-Code	8012667008550



Box



Gehärteter



Korrigiert



18Ni
CrMo5