

MAS-403 BT, CORPO MANDRINO BILANCIATO, PER FRESE
CILINDRICHE FRONTALI SECONDO NORMA DIN 481, PER FRESE CON
SCANALATURA...

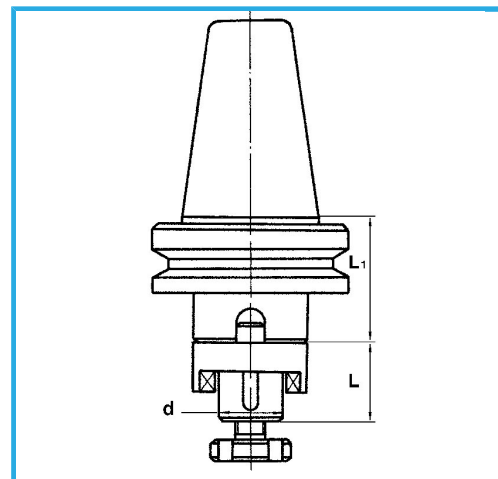

€119,00



BT	40
d - h6	27 mm
L	33 mm
L1	35 mm
Peso lordo	2,00 kg
Codice EAN	8012667008550



Scatola



Temprato



Rettificato



18Ni
CrMo5

-