

MAS-403 BT, AUSGEWUCHTETES SPANNFUTTERGEHÄUSE, FÜR
ZYLINDRISCHE SCHAFTFRÄSER NACH DIN 481, FÜR FRÄSER...

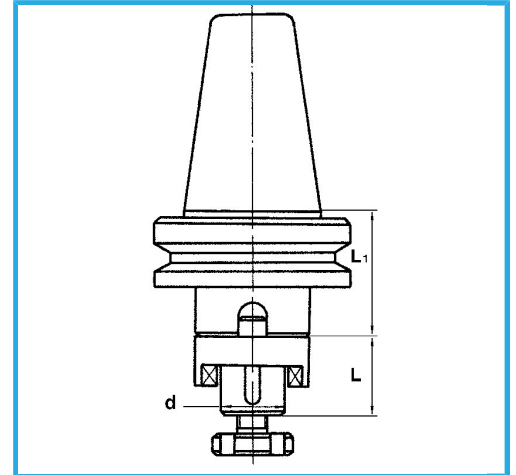

BT	50
d - h6	27 mm
L	33 mm
L1	35 mm
Bruttogewicht	4,36 kg
EAN-Code	8012667008598



Box



Gehärteter



Korrigiert



18Ni
CrMo5