

MAS-403 BT, AUSGEWUCHTETES SPANNFUTTERGEHÄUSE, FÜR
ZYLINDRISCHE SCHAFTFRÄSER NACH DIN 481, FÜR FRÄSER...

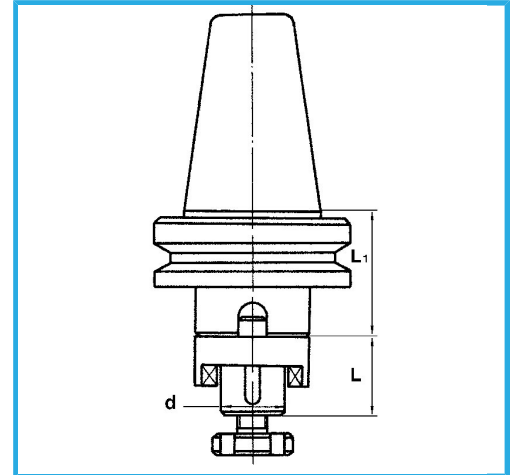

BT	40
d - h6	32 mm
L	38 mm
L1	40 mm
Bruttogewicht	2,12 kg
EAN-Code	8012667008567



Box



Gehärteter



Korrigiert



18Ni
CrMo5