

MAS-403 BT, BALANCED CHUCK BODY, FOR CYLINDRICAL END MILLS ACCORDING TO DIN 481, FOR MILLING CUTTERS WITH LONGITUDINAL GROOVE...

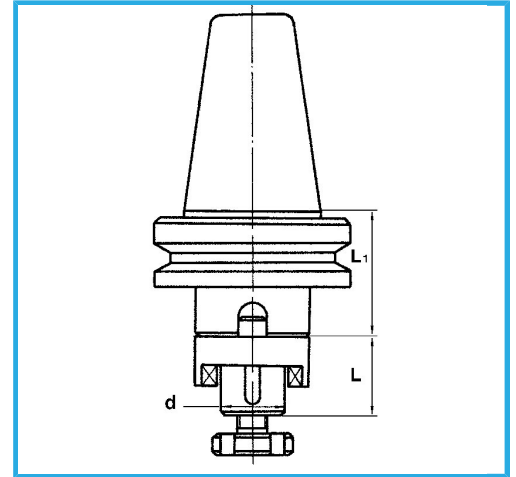

BT	40
d - h6	32 mm
L	38 mm
L1	40 mm
Gross weight	2,12 kg
EAN Code	8012667008567



Box



Tempered



Grounded



18Ni
CrMo5