

MAS-403 BT, CON CUERPO EQUILIBRADO, PARA FRESAS CILÍNDRICAS SEGÚN DIN 481, PARA FRESAS CON RANURA LONGITUDINAL DIN...

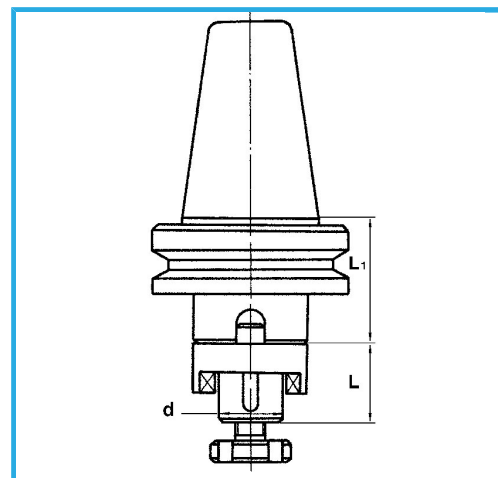

€132,00



Buril	40
d - h6	32 mm
L	38 mm
L1	40 mm
Peso bruto	2,12 kg
Codigo de barras	8012667008567



Caja



Templado



Rectificado



18Ni
CrMo5