

MAS-403 BT, AUSGEWUCHTETES SPANNFUTTERGEHÄUSE, FÜR
ZYLINDRISCHE SCHAFTFRÄSER NACH DIN 481, FÜR FRÄSER...

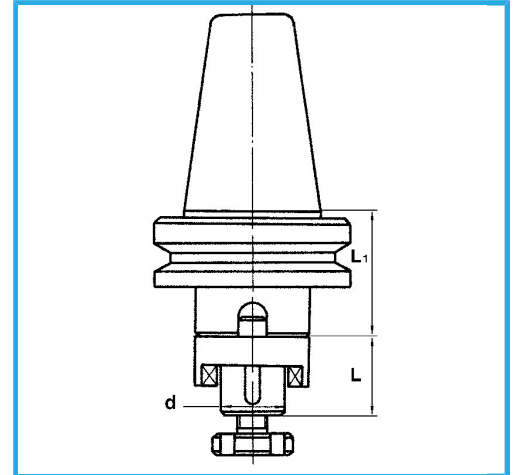

BT	50
d - h6	32 mm
L	38 mm
L1	40 mm
Bruttogewicht	4,76 kg
EAN-Code	8012667008604



Box



Gehärteter



Korrigiert



18Ni
CrMo5