

MAS-403 BT, CORPO MANDRINO BILANCIATO, PER FRESE
CILINDRICHE FRONTALI SECONDO NORMA DIN 481, PER FRESE CON
SCANALATURA...

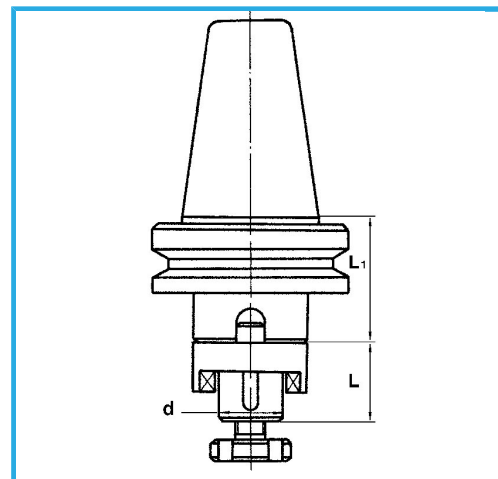

€177,00



BT	50
d - h6	32 mm
L	38 mm
L1	40 mm
Peso lordo	4,76 kg
Codice EAN	8012667008604



Scatola



Temprato



Rettificato



18Ni
CrMo5