

MAS-403 BT, AUSGEWUCHTETES SPANNFUTTERGEHÄUSE, FÜR
ZYLINDRISCHE SCHAFTFRÄSER NACH DIN 481, FÜR FRÄSER...

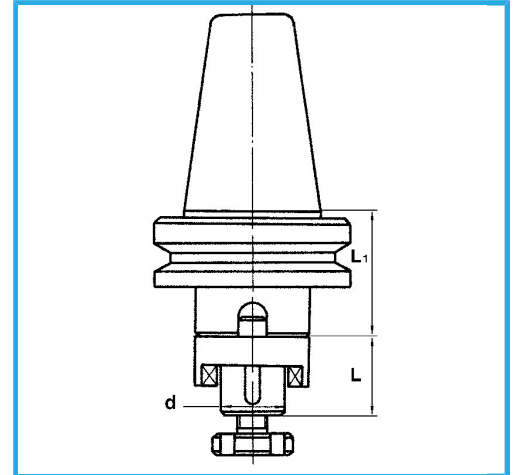

BT	50
d - h6	40 mm
L	41 mm
L1	40 mm
Bruttogewicht	4,18 kg
EAN-Code	8012667008611



Box



Gehärteter



Korrigiert



18Ni
CrMo5