

DIN 2080, AUSGEWUCHTETES SPANNFUTTERGEHÄUSE, FÜR
ZYLINDRISCHE SCHAFTFRÄSER NACH DIN 481, FÜR FRÄSER MIT..

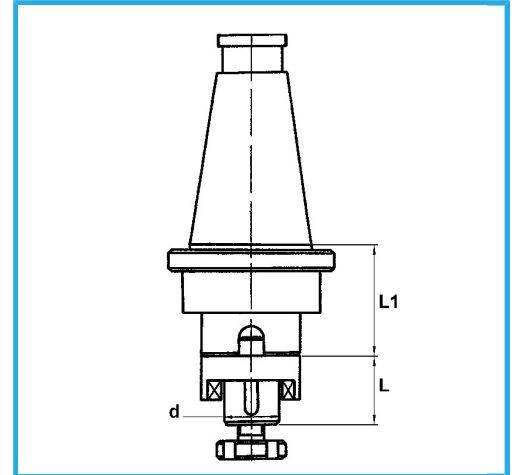

ISO	40
d - h6	16 mm
L	27 mm
L1	35 mm
Bruttogewicht	1,24 kg
EAN-Code	8012667008284



Box



Korrigiert



18Ni
CrMo5

-