

DIN 2080, CORPO MANDRINO BILANCIATO, PER FRESE CILINDRICHE FRONTALI SECONDO NORMA DIN 481, PER FRESE CON SCANALATURA...

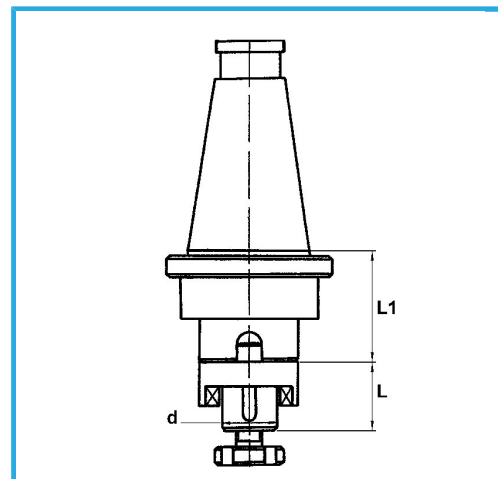

€158,00



ISO	50
d - h6	22 mm
L	31 mm
L1	35 mm
Peso lordo	3,22 kg
Codice EAN	8012667008338



Scatola



Rettificato

18Ni
CrMo5