

DIN 2080, CORPO MANDRINO BILANCIATO, PER FRESE CILINDRICHE FRONTALI SECONDO NORMA DIN 481, PER FRESE CON SCANALATURA...

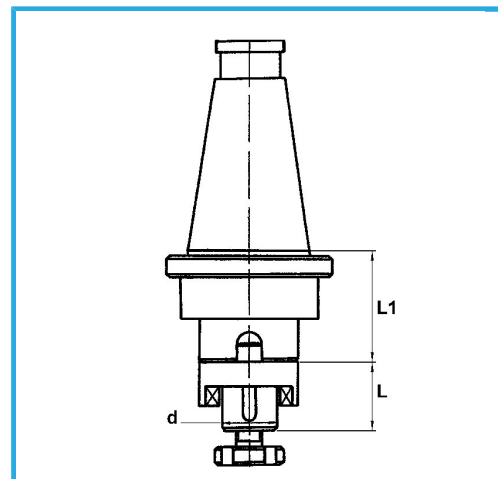

€131,00



ISO	40
d - h6	27 mm
L	33 mm
L1	40 mm
Peso lordo	1,99 kg
Codice EAN	8012667008307



Scatola



Rettificato



18Ni
CrMo5