

DIN 2080, AUSGEWUCHTETES SPANNFUTTERGEHÄUSE, FÜR  
ZYLINDRISCHE SCHAFTFRÄSER NACH DIN 481, FÜR FRÄSER MIT..

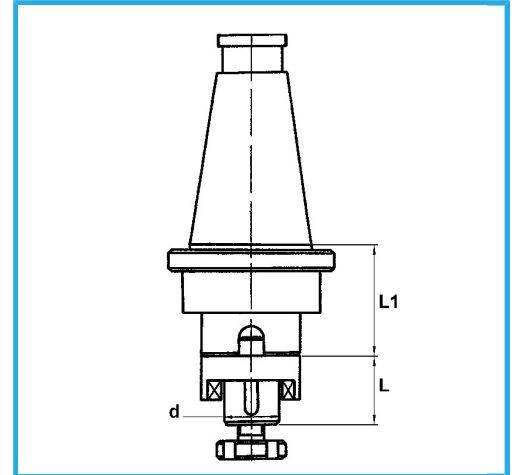

ISO	50
d - h6	27 mm
L	33 mm
L1	35 mm
Bruttogewicht	3,57 kg
EAN-Code	8012667008345



Box



Korrigiert



18Ni  
CrMo5

-