

DIN 2080, BALANCED CHUCK BODY, FOR CYLINDRICAL END MILLS
ACCORDING TO DIN 481, FOR MILLING CUTTERS WITH LONGITUDINAL
GROOVE DIN...

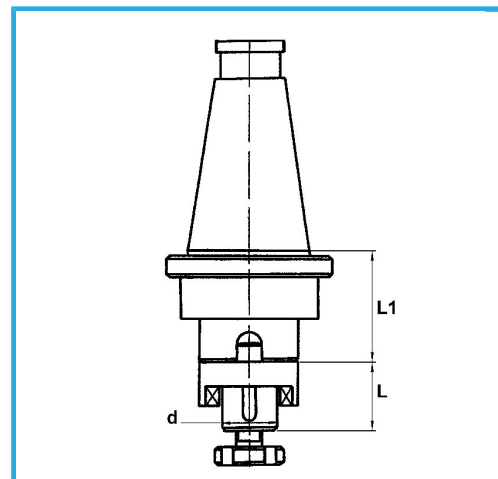

ISO	50
d - h6	27 mm
L	33 mm
L1	35 mm
Gross weight	3,57 kg
EAN Code	8012667008345



Box



Grounded



18Ni
CrMo5

-