

DIN 2080, AUSGEWUCHTETES SPANNFUTTERGEHÄUSE, FÜR
ZYLINDRISCHE SCHAFTFRÄSER NACH DIN 481, FÜR FRÄSER MIT..

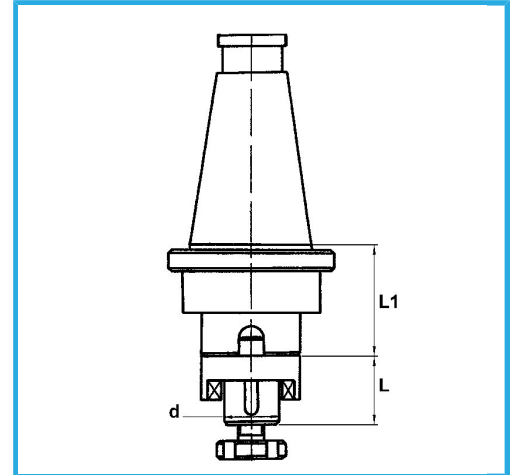

ISO	40
d - h6	32 mm
L	38 mm
L1	40 mm
Bruttogewicht	2,45 kg
EAN-Code	8012667008314



Box



Korrigiert



18Ni
CrMo5

-