

DIN 2080, CORPO MANDRINO BILANCIATO, PER FRESE CILINDRICHE FRONTALI SECONDO NORMA DIN 481, PER FRESE CON SCANALATURA...

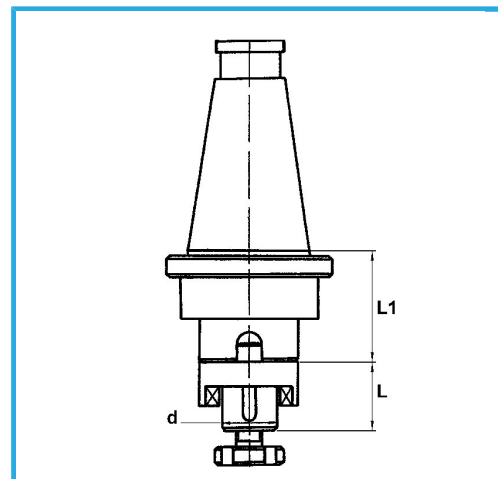

€131,00



ISO	40
d - h6	32 mm
L	38 mm
L1	40 mm
Peso lordo	2,45 kg
Codice EAN	8012667008314



Scatola



Rettificato

18Ni  
CrMo5