

DIN 2080, BALANCED CHUCK BODY, FOR CYLINDRICAL END MILLS
ACCORDING TO DIN 481, FOR MILLING CUTTERS WITH LONGITUDINAL
GROOVE DIN...

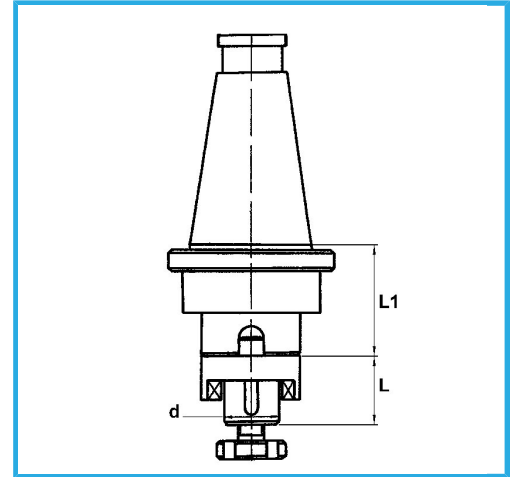

ISO	50
d - h6	32 mm
L	38 mm
L1	40 mm
Gross weight	3,85 kg
EAN Code	8012667008352



Box



Grounded



18Ni
CrMo5

-