

DIN 2080, CORPO MANDRINO BILANCIATO, PER FRESE CILINDRICHE FRONTALI SECONDO NORMA DIN 481, PER FRESE CON SCANALATURA...

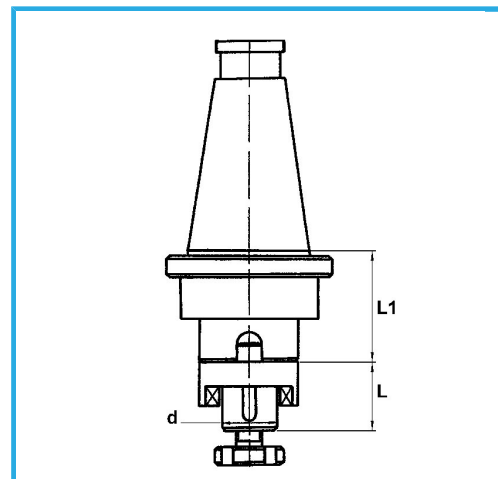

€169,00



ISO	50
d - h6	32 mm
L	38 mm
L1	40 mm
Peso lordo	3,85 kg
Codice EAN	8012667008352



Scatola



Rettificato

18Ni
CrMo5